



LEFROY BROOKS

IBROC HOUSE ESSEX ROAD
HODDESDON HERTS EN11 0QS UK
T: +44 (0)1992 708 316 F: +44 (0)1992 708 317

GD-8704

EXPOSED GODOLPHIN THERMOSTATIC VALVE
WITH RISER KIT, HANDSET, LEVER DIVERTER, 8" ROSE
AND ADJUSTABLE RISER PIPE BRACKET

DIMENSIONAL DATA SHEET

DATE: 25 May 2010

ISSUE: 050 C

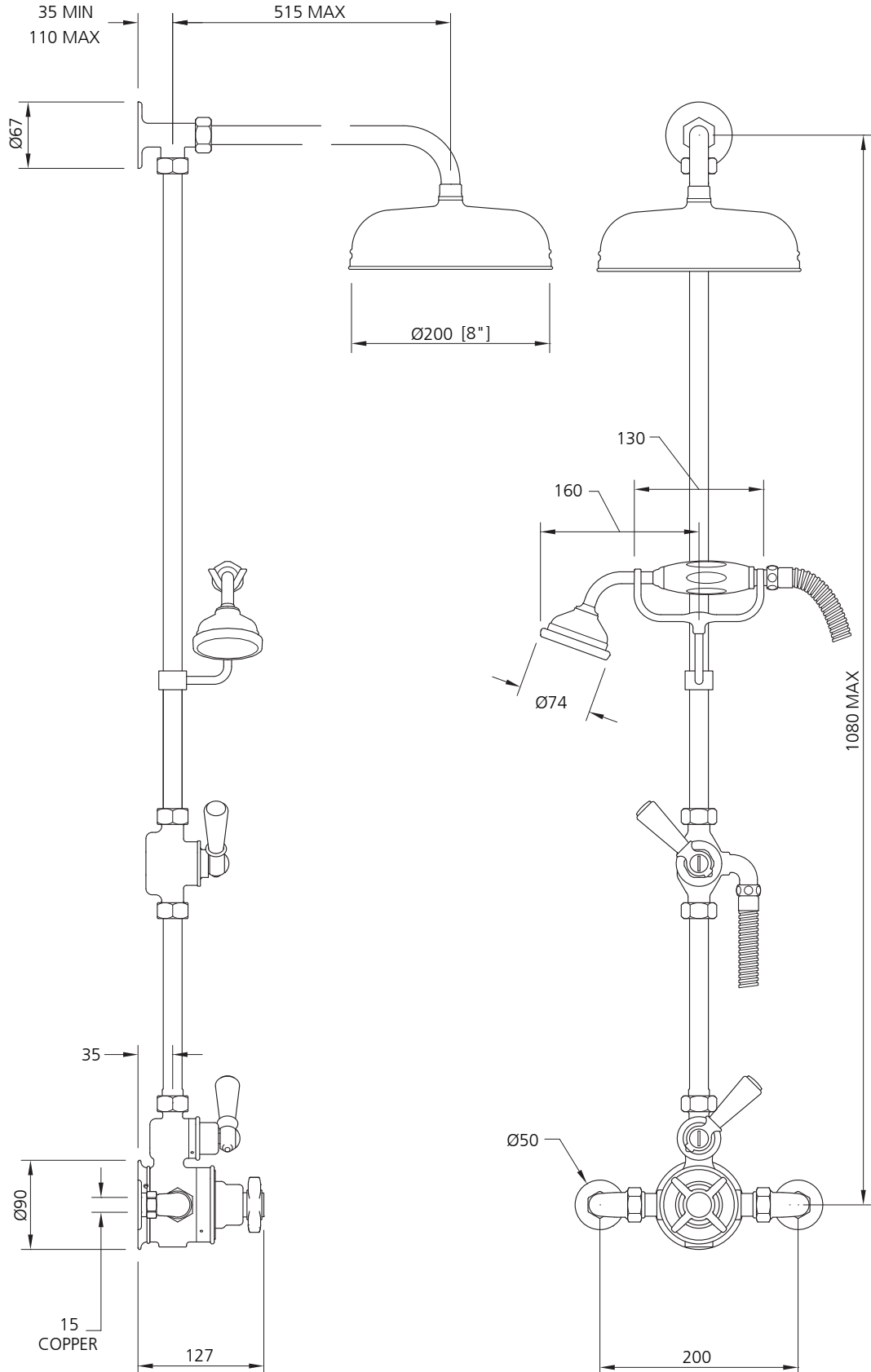

©COPYRIGHT 2010. CHRISTO LEFROY BROOKS. ALL RIGHTS RESERVED.

DIMENSIONS IN MILLIMETRES

WHILST EVERY EFFORT IS MADE TO ENSURE THE ACCURACY OF THESE DATA SHEETS THEY ARE SUBJECT TO CHANGE WITHOUT NOTICE AS PART OF THE COMPANY'S PRODUCT DEVELOPMENT PROCESS