



INSTALLATION, OPERATING & MAINTENANCE INSTRUCTIONS

M2-5103

FLEETWOOD 30-INCH TOWEL RAIL



LEFROY BROOKS

Contents

Dimensions	3
Installation Procedure	4
Parts List	6
Fault Finder	7
Safety Tips, Care and Maintenance	8
Guarantee	9

Dimensions in Inches (& Millimetres)

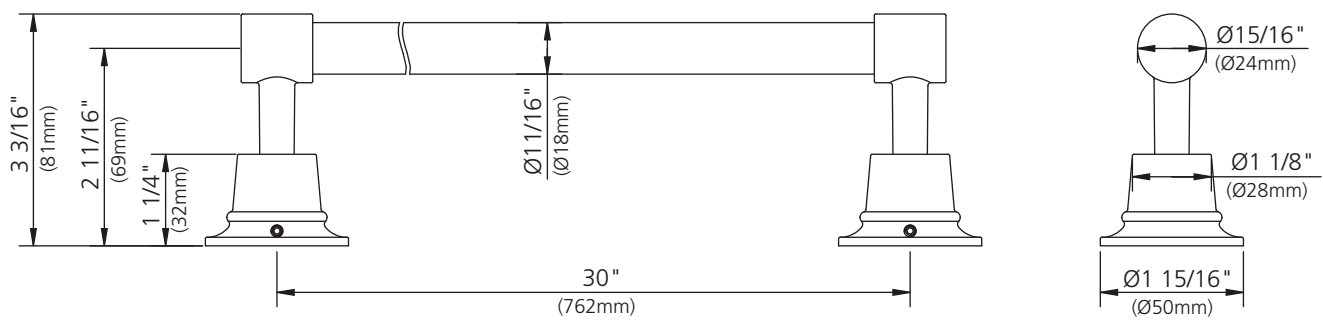

Whilst every effort is made to ensure accuracy, design and dimensions are subject to change without notice as part of the company's product development process.

Installation Procedure

Steps 1-2

Lefroy Brooks always recommends that plumbing products be installed by a licensed professional. Shut off main water supply before installation.

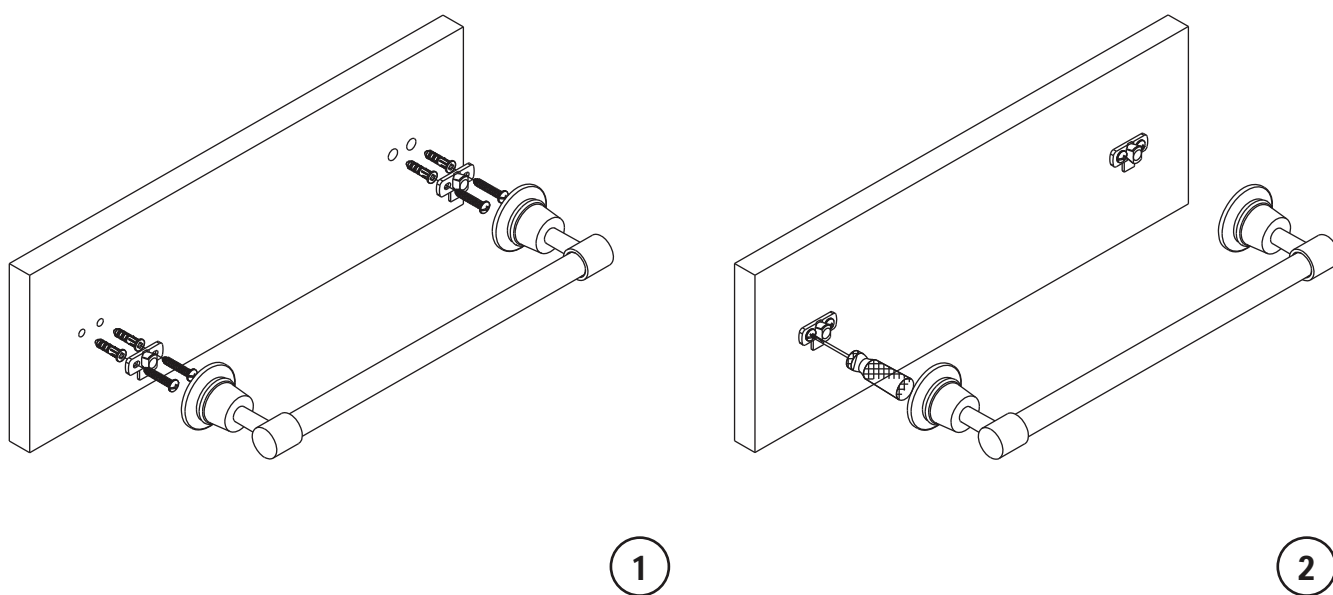

- 1** Position the mounting bracket on the wall where required. Please note the direction of the bracket should be as shown. Mark the location of mounting screws. Drill holes in the wall to fit the anchors. Tap the plastic anchor into the hole with a hammer.
- 2** Position the mounting bracket to be mounted on the wall, then thread the fixing screws through the mounting hole into the plastic anchor. Turn the screws slowly until they are tight.

Lefroy Brooks always recommends that plumbing products be installed by a licensed professional. Shut off main water supply before installation.

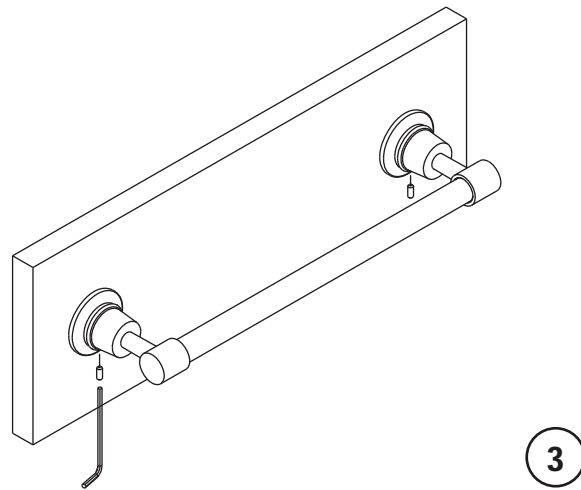

- 3** Place assembly over the mounting bracket with set screws facing down. Tighten the set screws.

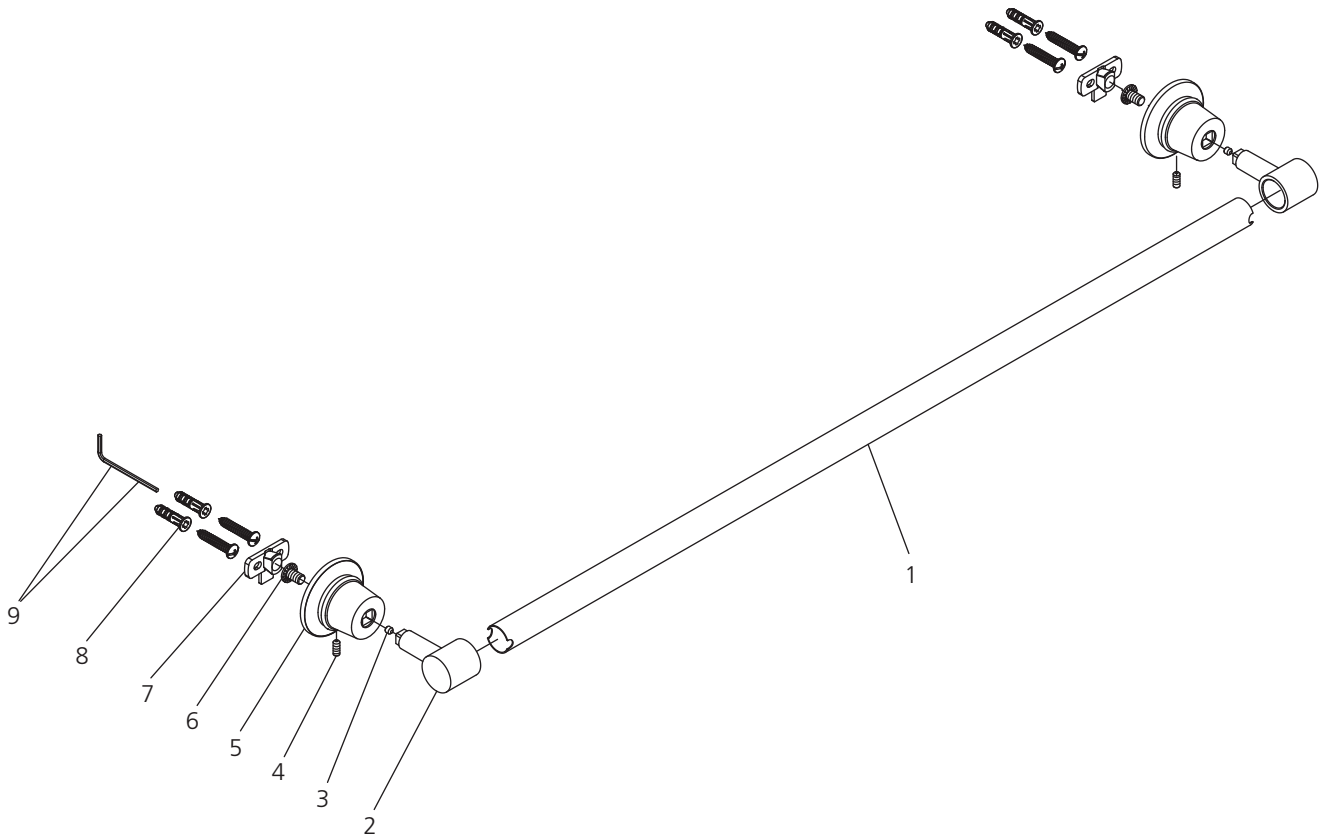

- | | | | |
|---|---------------------|---|--------------------------------|
| 1 | Towel rail (250351) | 6 | Screw (292550) |
| 2 | Post (244043) | 7 | Mounting bracket (293014-3) |
| 3 | Set screw (065086) | 8 | Anchor bolt and screw (290411) |
| 4 | Set screw (292547) | 9 | Allen key (031003) |
| 5 | Bracket (245025) | | |
| 6 | Screw (292550) | | |

Fault Finder

Fault	Cause	Rectification
Loose towel rail.	The fixing screw is not tightened properly.	Check and tighten properly the fixing screw.

Safety Tips, Care and Maintenance

Safety Tips

If you are soldering during faucet installation, remove cartridges, seats, gaskets and washers prior to applying flame, otherwise you will void the warranty.

Cover drain openings to avoid losing small parts.

When cutting or soldering pipe, use safety glasses to protect your eyes.

Important Points

Prior to beginning installation. turn off the cold and hot water lines and open the old faucet to release built-up pressure.

Overtightening nuts may cause damage.

Wrap all threaded connections with pipe tape available at your local plumbing supply store. Always wrap in a clockwise direction. The fittings should be installed by a state-licensed plumber.

Please note:

When there is a difference in water pressure between hot and cold supplies to the mixing valve, the pressures should be equalized by a plumber in accordance with best practice and legislation.

Maintenance

Your new bathroom faucet is designed for years of trouble-free performance. Keep it looking new by cleaning it periodically with a soft cloth. Avoid abrasive cleaners, wire wool and harsh chemicals as these will dull the finish and void your warranty.

Routine Maintenance

The frequency and extent of attention required will vary according to prevailing site and operational conditions, however a 12 monthly maintenance schedule is recommended.

If the product has operated satisfactorily for some time, but performance has been degraded, please check the Fault Finder section to identify the problem.

Maintenance Check List

- Worn or damaged seals and washers
- Damaged seal faces
- Thread wear
- Incorrect adjustment
- Component failure
- Debris or limescale build-up

Guarantee

Guarantee of Quality

This product is guaranteed against faulty materials and workmanship for 12 months from date of purchase. For the guarantee to be valid, the unit must be installed by a competent person, in accordance with the instruction booklet.

Any part found to be defective during the guarantee period, will (at our option) be repaired or replaced, free of charge, provided the unit has been installed, and properly used in accordance with the instruction booklet.

Our products correspond to the valid technical and water supply standards as well as the relevant approvals requirements. We guarantee them to be free of design and production faults at the time of delivery and that with correct use and care in accordance with our printed instructions they will function reliably.

Guarantee period

- The guarantee is valid in private homes for 5 years from the purchase date. Proof of purchase has to be provided when making a guarantee claim.
- By use in commercial or institutional applications the guarantee is valid for 1 year after first use.

To make a guarantee claim, proof of purchase or, the beginning of use is required.

Not Covered by this Guarantee

Damage or defects arising from incorrect installation, improper use or lack of maintenance.
Installed product damaged in transit
Consequential loss, damage or product removal and installation costs.

Lefroy Brooks is not responsible for any on site labour charges.

For additional assistance or service call

718-302-5292

9am to 5pm EST Monday to Friday



L E F R O Y B R O O K S

www.lefroybrooks.com

LEFROY BROOKS INC, 1828 TROUTMAN STREET, RIDGEWOOD, NY, 11385
TELEPHONE: 718-302-5292. FAX: 718-302-4177

The use of trademarks, product design and artwork is subject to licence or agreement with Christo A. Lefroy Brooks. The design registrations, trademark registrations and copyrights are protected by law and the use or reproduction outside the terms of an agreement is prohibited. The right to modify designs and dimensions is reserved. Christo Lefroy Brooks is a member of ACID (Anti Copying in Design).

COPYRIGHT©LBIP LTD 2013