

INSTALLATION INSTRUCTIONS

# Y1-1022

HAND SHOWER WITH DECK HOLSTER TRIM ONLY, TO SUIT R1-4026

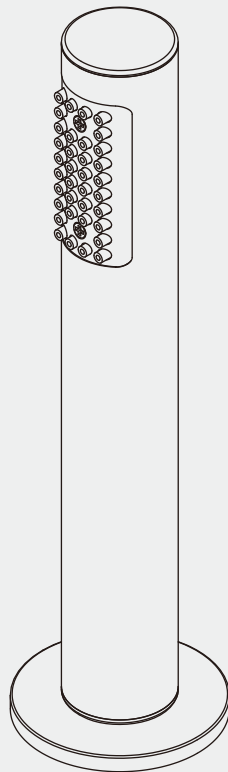

LEFROY BROOKS

# What you need to know

## Tools:

Adjustable Wrench  
Groove Joint Pliers  
Hacksaw  
Phillips Screwdriver  
Pipe Tape  
Spatula  
Spirit Level

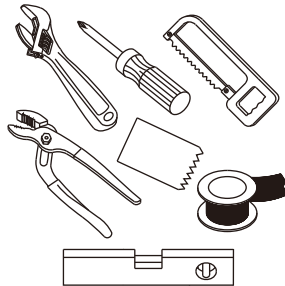

## Safety Tips

If you are soldering during faucet installation, remove cartridges, seats, gaskets and washers prior to applying flame, otherwise you will void the warranty.

Cover drain openings to avoid losing small parts.

When cutting or soldering pipe, use safety glasses to protect your eyes.

## Things You May Need

Correct installation may vary depending on previous faucet installation. All necessary supplies required for faucet installation are not included, but may be found where plumbing supplies are sold. It is suggested that IAPMO and/or CSA approved plumbing supplies are used during installation.

## Standards

IAPMO/cUPC Listed  
Meets A112.18.1

## Maintenance

Your new bathroom faucet is designed for years of trouble-free performance.

Keep it looking new by cleaning it periodically with a soft cloth. Avoid abrasive cleaners, wire wool and harsh chemicals as these will dull the finish and void your warranty.

## Important Points

Prior to beginning installation, turn off the cold and hot water lines and open the old faucet to release built-up pressure.

Overtightening nuts may cause damage.

Wrap all threaded connections with pipe tape available at your local plumbing supply store. Always wrap in a clockwise direction. The fittings should be installed by a state-licensed plumber.

## Flow Rate

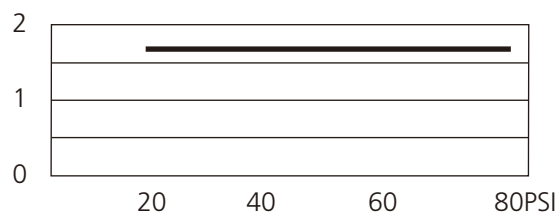

Please note :

Final achievable flow rate is dependent on the outlets fitted, see relevant outlets (spouts, roses, sprays) for fully assembled product flow rate.

# Steps 1-2

## Installation Procedure

Lefroy Brooks always recommends that plumbing products be installed by a licensed professional. Shut off main water supply before installation.

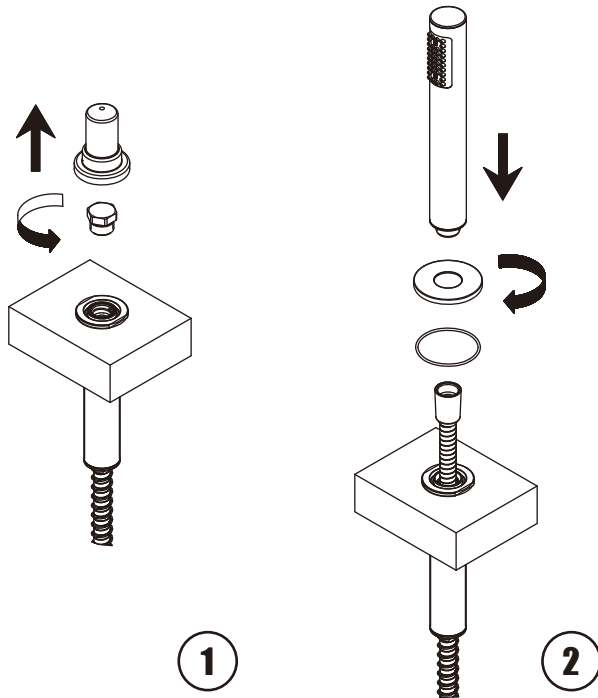

**1** Make sure that main water supply is shut off before further installation. Take off rubber protective cap and plug from valves, as well as the underneath protective bubble bags.

**2** Install escutcheon and hand shower.

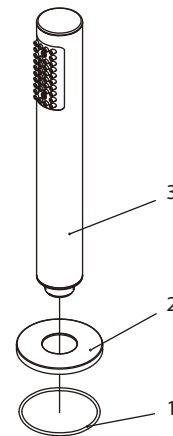
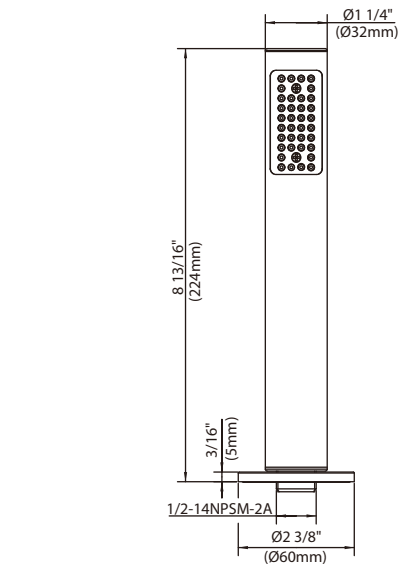

- 1 O-ring (004640N)
- 2 Escutcheon (071390)
- 3 Handshower (S2111104)

This product requires the installation of certified atmospheric vacuum breaker (AVB) installed in-between the shut off valve and hose inlet. The AVB should be installed so its vent ports are not pointing in an upward direction. Should you be unfamiliar with an AVB, we recommended consulting a plumbing professional.



valve

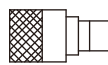

AVB



HOSE

Please note:

When there is a difference in water pressure between hot and cold supplies to the mixing valve, the pressures should be equalized by a plumber in accordance with best practice and legislation.

For additional assistance or service call

**718-302-5292**

**9am to 5pm EST Monday to Friday**



LEFROY BROOKS

[www.lefroybrooks.com](http://www.lefroybrooks.com)

LEFROY BROOKS INC, 1828 TROUTMAN STREET, RIDGEWOOD, NY, 11385  
TELEPHONE: 718-302-5292. FAX: 718-302-4177

The use of trademarks, product design and artwork is subject to licence or agreement with LBIP Ltd. The design registrations, trademark registrations and copyrights are protected by law and the use or reproduction outside the terms of an agreement is prohibited. The right to modify designs and dimensions is reserved. Christo Lefroy Brooks is a member of ACID (Anti Copying in Design).