

INSTALLATION INSTRUCTIONS

M1-4600

8-INCH BRASS SHOWER ROSE

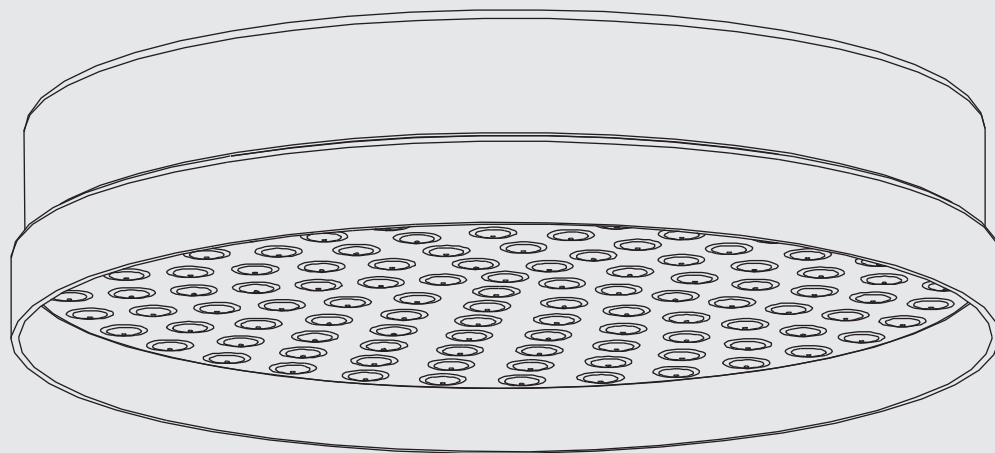

LEFROY BROOKS

What you need to know

Tools:

Adjustable Wrench
Groove Joint Pliers
Hacksaw
Phillips Screwdriver
Pipe Tape
Spatula
Spirit Level

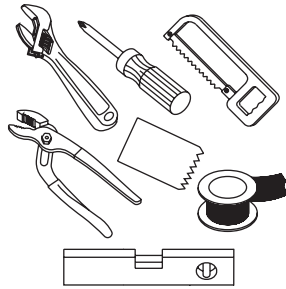

Maintenance

Your new bathroom faucet is designed for years of trouble-free performance.

Keep it looking new by cleaning it periodically with a soft cloth. Avoid abrasive cleaners, wire wool and harsh chemicals as these will dull the finish and void your warranty.

Safety Tips

If you are soldering during faucet installation, remove cartridges, seats, gaskets and washers prior to applying flame, otherwise you will void the warranty.

Cover drain openings to avoid losing small parts.

When cutting or soldering pipe, use safety glasses to protect your eyes.

Important Points

Prior to beginning installation, turn off the cold and hot water lines and open the old faucet to release built-up pressure.

Overtightening nuts may cause damage.

Wrap all threaded connections with pipe tape available at your local plumbing supply store. Always wrap in a clockwise direction. The fittings should be installed by a state-licensed plumber.

Please note:

When there is a difference in water pressure between hot and cold supplies to the mixing valve, the pressures should be equalized by a plumber in accordance with best practice and legislation.

Things You May Need

Correct installation may vary depending on previous faucet installation. All necessary supplies required for faucet installation are not included, but may be found where plumbing supplies are sold. It is suggested that IAPMO and/or CSA approved plumbing supplies are used during installation.

Standards

IAPMO/cUPC Listed
Meets A112.18.1

Flow Rate

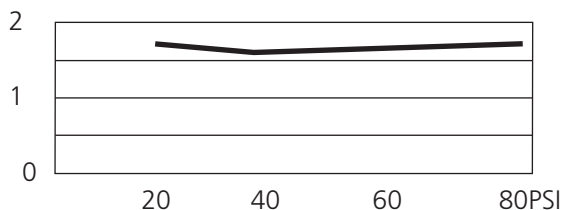

Please note :

Final achievable flow rate is dependent on the outlets fitted, see relevant outlets (spouts, roses, sprays) for fully assembled product flow rate.

Steps 1-4

Installation Procedure

Lefroy Brooks always recommends that plumbing products be installed by a licensed professional. Shut off main water supply before installation.

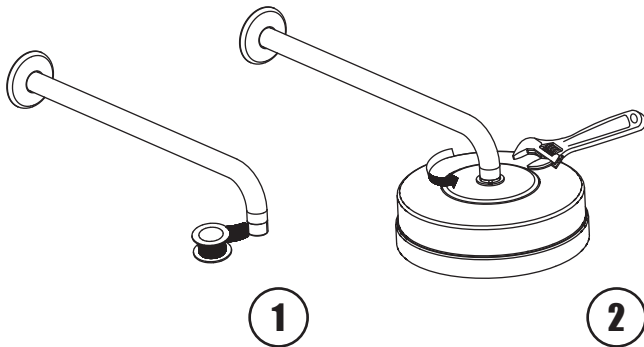
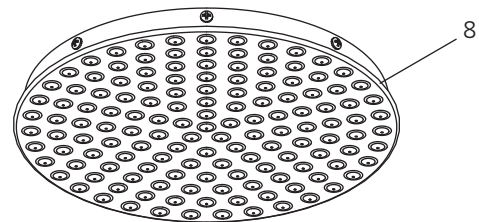
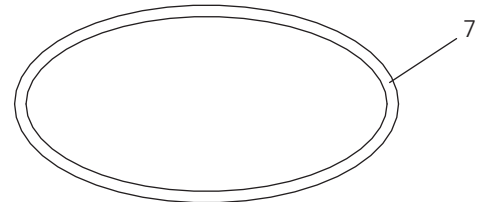
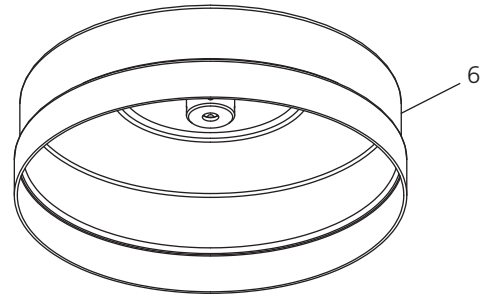
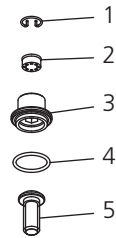
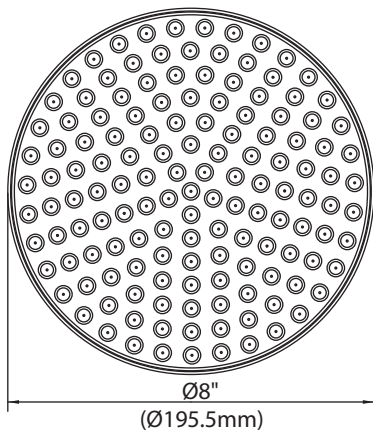
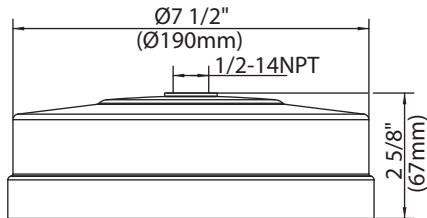

1 Apply pipe tape on the threads of shower arm (which is not included in this product package).

2 Tighten the shower head to shower arm with wrench.

- 1 Clip (112696)
- 2 Flow restrictor (519018)
- 3 Seat (112697)
- 4 O-ring (004547)
- 5 Screw (558976-R2)
- 6 Body (055612)
- 7 O-ring (117022-R5)
- 8 Front cover (117022)

For additional assistance or service call

718-302-5292

9am to 5pm EST Monday to Friday



LEFROY BROOKS

www.lefroybrooks.com

LEFROY BROOKS INC, 1828 TROUTMAN STREET, RIDGEWOOD, NY, 11385
TELEPHONE: 718-302-5292. FAX: 718-302-4177

The use of trademarks, product design and artwork is subject to licence or agreement with LBIP Ltd. The design registrations, trademark registrations and copyrights are protected by law and the use or reproduction outside the terms of an agreement is prohibited. The right to modify designs and dimensions is reserved. Christo Lefroy Brooks is a member of ACID (Anti Copying in Design).

© LBIP LTD 2012